

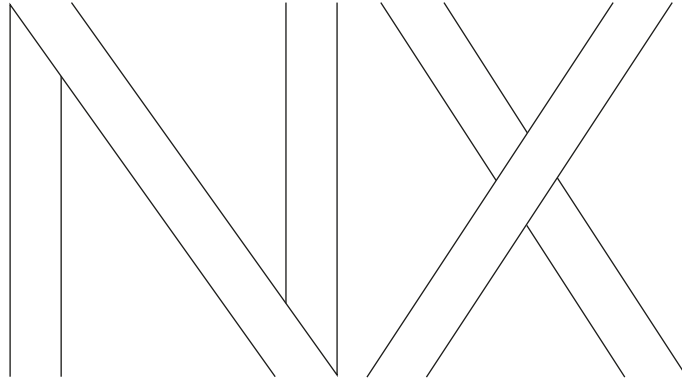

THE ALL-NEW NX

SELF-CHARGING HYBRID
AND PLUG-IN HYBRID

 **LEXUS**
EXPERIENCE AMAZING



At Lexus, we have a lot to be proud of. A pioneer and leader in luxury car electrification for more than 15 years. Over 2 million Lexus Self-Charging Hybrids on the road in every corner of the globe. A comprehensive range of electrified models that stand out for their sophistication, proven quality and award-winning reliability. These may be impressive facts, but for Lexus, performance is more than just numbers. And electrification is more than just batteries and motors. It's the unique chance to define a new kind of driving pleasure.

So when you make the human experience the hero, there's only one question that matters: how do we make you feel? Just drive the new NX 350h Self-Charging Hybrid or NX 450h+ Plug-in Hybrid and you'll know what we mean.

This is Lexus Electrified.



01. FEEL MORE SOPHISTICATED
Pages 04-05



02. FEEL MORE EXHILARATED
Pages 06-09



03. FEEL MORE LUXURIOUS
Pages 10-13



04. FEEL MORE REASSURED
Pages 14-15



05. FEEL MORE CONNECTED
Pages 16-17



06. FEEL MORE PIONEERING
Pages 18-23



07. MODELS
Pages 24-27



08. GRADES
Pages 28-30



09. F SPORT
Page 31



10. FEATURES
Pages 32-35



11. TECHNOLOGY
Pages 36-44



12. ACCESSORIES
Pages 45-47



13. COLOURS
Pages 48-51



14. EQUIPMENT
Pages 52-59



15. TECHNICAL DATA
Pages 60-61



16. FEEL MORE VALUED
Pages 62-63

DESIGN YOU CAN FEEL

STRIKING LOOKS INSIDE AND OUT MAKE THE ALL-NEW NX MORE DESIRABLE THAN EVER.

Excitement comes as standard - and comes instantly - with the new NX luxury mid-size SUV. Its bold and beautifully proportioned styling, highlighted by the sculpted front fascia, intricate signature grille and wide rear stance, hint at the vitality that lies waiting under its skin. So, too, do the skilfully crafted character lines and the long "sports car"-like bonnet, in a look completed by the sleek rear light signature and the stylish new 20" wheels. Whether parked or in motion, the elegant new NX exudes an undeniably assured presence, in keeping with its exclusive pedigree.

FUNCTIONAL BEAUTY INSPIRED BY ADVANCED TECHNOLOGY AND FASHION. Heralding a new chapter in Lexus design, the NX exterior is a fusion of vital dynamism, innovation through advanced technology and 'cool' contemporary fashion. The result is a sophistication that goes beyond pure aesthetics. Lexus designers worked hand in hand with the performance engineers to create an ultra-stable, aerodynamically efficient car. This is "functional beauty".

UNIQUE 'TAZUNA' COCKPIT WITH 14" TOUCHSCREEN DISPLAY. The excitement extends inside, to the unique 'Tazuna' cockpit. Derived from the futuristic Lexus LF-30 concept vehicle, this human-centred design, with all key instruments placed around the driver, evokes a sense of control and anticipation for the drive ahead. Meanwhile, the digital instrument display and large 14" High Definition Lexus Link Multimedia screen support the modern, progressive character introduced by the exterior design.

Whether as driver or passenger, get ready to feel more in every moment.

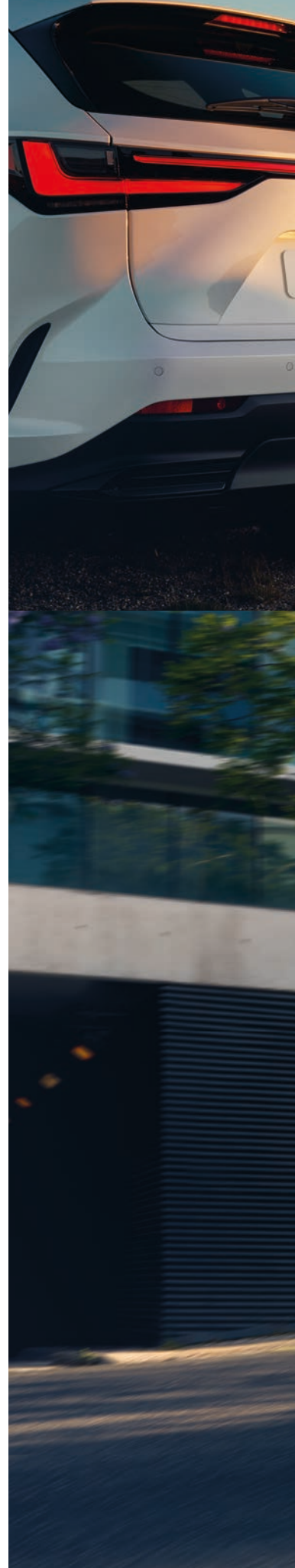





FEEL MORE EXHILARATED

"The human-centred design means focusing on how the driver feels, so that they can control the vehicle naturally and the vehicle moves naturally in response."

NX Chief Engineer
Takeaki Kato



REDEFINING HYBRID PERFORMANCE

CLASS-LEADING HYBRID AND PLUG-IN HYBRID POWERTRAINS AND RAZOR-SHARP DYNAMICS SET THE ALL-NEW NX APART FROM OTHER SUVs.

Boasting the most advanced Lexus Plug-In Hybrid and Lexus Self-Charging Hybrid powertrains, the new NX is more economical and more environmentally friendly than petrol- or diesel-powered mid-size SUVs. The product of over 15 years of experience in pioneering electrification, the Lexus Self-Charging Hybrid supplies the NX 350h with more power and acceleration yet best-in-class economy and emissions. Extending the Lexus Electrified line-up, the NX 450h+ sets a new standard for plug-in hybrids. It's not just the 98 km urban range in EV zero emissions mode, the 309 DIN hp of power and rapid acceleration that impress. It's the class-leading hybrid efficiency when the battery is depleted, with no sacrifice in boot space or fuel tank capacity. This is a car to redefine the plug-in hybrid.

RIGID NEW CHASSIS AND LOWER CENTRE OF GRAVITY. At the wheel of the new NX, the sensation of power and agility is immediately apparent, instilling an instant confidence in the driver. Navigating motorways, mountain passes and city streets with ease, the very quietness of the drive strengthens your connection with the road, emphasising the benefits of the enhanced aerodynamics, wider tread and lower centre of gravity. When cornering, accelerating or braking, you can feel a wonderful interplay at work between the powertrain, rigid new chassis and ultra-precise steering. You're experiencing that sweet spot between ride comfort and dynamics which we call the Lexus 'Driving Signature'. And to savour it in its fullest form, sit into the exhilarating new NX F SPORT.

This is how a luxury mid-size SUV should feel.









FEEL MORE LUXURIOUS

HAVEN OF CRAFTSMANSHIP

THE BEAUTIFULLY FINISHED INTERIOR OF THE ALL-NEW NX INDULGES THE SENSES OF BOTH DRIVER AND PASSENGERS.

The feeling of anticipation sets in long before you get to drive the new NX. Sensing your arrival, the door handles illuminate, highlighting obstacles like puddles as you approach. Once inside, the stylish instrument displays light up to greet you and multi-colour ambient lighting allows you to transform the cabin to suit your mood from a palette of 64 atmospheric colours. This is Omotenashi - an ancient Japanese philosophy of hospitality, rooted in anticipating your needs even before you know them yourself. You find it everywhere inside the new NX.

A UNIQUE COCKPIT EXPERIENCE. Sitting in the driver-centred 'Tazuna' cockpit, your focus is squarely on the road ahead, yet all around the craftsmanship of the famed Lexus Takumi artisans is arousing your senses. The elegant finish of the door inserts. The softness of the sumptuous seating. The exceptional quietness, interrupted only by the new multimedia system's natural voice assistant, intelligently understanding and responding to your commands.

TRAVELLING FIRST CLASS. You're feeling pampered, and so are your passengers. The comfort and spaciousness of the new NX interior carries the unmistakable feel of a business lounge, the perfect auditorium for the standard 10-speaker or Mark Levinson® 17-speaker Premium Surround sound systems. Exploiting the acoustic properties of the NX, these systems offer a memorable home theatre experience transposed to your car. The performance is made all the more pleasurable by S-Flow climate control, which, recognising which seats are occupied or where the sun is shining, adjusts the interior climate accordingly.

And by the near-silent hum of the hybrid powertrain, taking you to your destination in the serene manner you expect of a Lexus.







LEXUS

21.5

80 40



SAFER THROUGH INNOVATION

SAFETY BREAKTHROUGHS ABOUND IN THE ALL-NEW NX, GIVING THE DRIVER A SPECIAL FEELING OF PROTECTION.

Technology is everywhere in the new NX. Some of it is evident, like the new 14" High Definition touchscreen with intuitive navigation and the Head-Up Display that projects speed, safety warnings and navigation commands directly onto the windshield. Some is hidden from view, like the innovations that today make up the most comprehensive standard safety package of any luxury mid-size SUV.

SAFETY THAT REASSURES. The feeling of well-being, which is at the heart of every Lexus, is raised to new levels in the NX. The latest Lexus Safety System + is like having your own co-pilot, keeping you safe in every driving situation, be it in city traffic or on the motorway, in daytime or at night, at intersections, on bends or during lane changes, with technology that is defining a new era in accident prevention. The upgraded Pre-Collision System, for example, can now detect motorcycles during the daytime and pedestrians at night. Making its debut on the new NX is e-Latch with Safe Exit Assist, that features electronically activated door locks which, in combination with Blind Spot Monitor, are automatically prevented from opening in the case of traffic approaching from behind.

For manoeuvring in confined spaces, the Digital Panoramic View Monitor provides a live 360° view around the NX and a virtual 3D image showing the car as if seen from above. There's even a view under the NX to help you when driving on rougher roads. Meanwhile, the Digital Rear-View Mirror, displaying images from a camera at the rear of the car is a boon, especially when the rear luggage space is loaded to the roof, or in poor weather.

MAKING YOUR LIFE EASIER. Your peace of mind is heightened further by an advanced new driver support feature. Advanced Park autonomously parks the NX at the press of a button, scanning the environment around you, with the ability to store parking spaces that you use frequently.

Wherever you travel in this car, it's safe in the knowledge that the latest technology is constantly at your side.

FEEL MORE CONNECTED

WELCOME TO LEXUS LINK

A WORLD OF MULTIMEDIA AND BREAK-THROUGH CONNECTIVITY
ENRICHES LIFE WITH THE NX IN A MYRIAD OF WAYS.

With the new NX, luxury goes beyond the tactile pleasures of sumptuous seats. Luxury is equally the peace of mind that comes from knowing you will reach your destination on time, in the most enjoyable, stress-free manner. And it is the seamless interaction of audio, navigation and online services for driver and passengers, enhancing each journey we make.

Welcome to Lexus Link, a new world of multimedia and connectivity created to complement our unique 'Omotenashi' service philosophy. With an extra-large 14" touchscreen, advanced voice recognition and smartphone integration, Lexus Link Multimedia offers an exceptionally fast and easy-to-use in-car experience. Meanwhile, the Lexus Link app on your smartphone helps you track journeys, schedule a service or even improve your hybrid driving style.

Transform your everyday with the new NX, both professionally and privately.



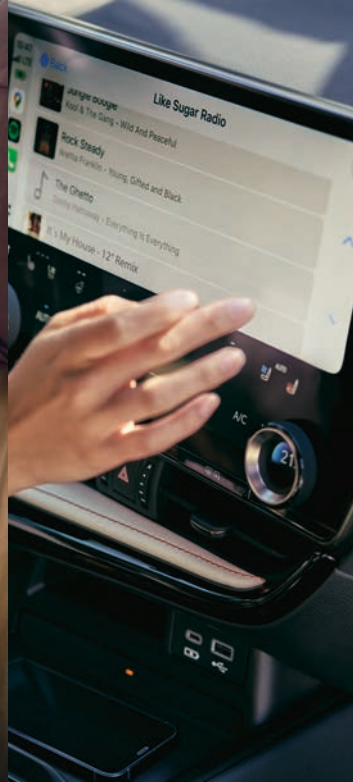

RAISING THE STANDARD FOR CONNECTIVITY.

The clever Lexus Link app boasts an array of connected services as standard. Driving Analytics tracks your journeys and highlights business trips. Find my Car guides you back to your car. You can receive notifications if you leave a window open or forget to switch off the headlights. And from the comfort of your home, you can remotely defrost the NX's windscreen, pre-set the air conditioning temperature, activate hazard warning lights or even lock and unlock your car. What's more, with the Premium Connectivity pack, you get cloud-based navigation & Voice Assistant; Road Events & Real Time Traffic information and parking availability.

MAXIMISING YOUR PLUG-IN HYBRID EXPERIENCE.

For maximum EV performance, you can monitor the charge level and range of the NX 450h+ Plug-in Hybrid remotely, on your mobile. Lexus Link Multimedia can locate charging stations across Europe on the in-car touchscreen, while the Lexus Link app allows you to check availability, charging speed and price. Easy to use, you'll even receive a monthly overview of charging sessions.

NEW 14" TOUCHSCREEN.

Lexus Link Multimedia on the new NX has been designed for maximum user engagement and exceptional speed and ease of use. At its heart is the 14" High Definition touchscreen. One of the largest available in this category of car, it is perfectly positioned for easy interaction while you drive. As well as allowing you to access information like navigation, audio and climate control, you can also display your favourite smartphone apps via Android Auto® or wireless Apple CarPlay®.

LEXUS VOICE ASSISTANT.

Artificial Intelligence and the cloud work together in the clever Lexus Voice Assistant, which spares you grappling with buttons while you're concentrating on the road ahead. The newly developed system understands natural language and the context of statements such as "I'm hungry" or "I'm cold" and can even recognise which passenger is speaking. Without taking your hands off the wheel, Lexus Voice Assistant allows you to interact in more than 100 different ways across phone, navigation, audio, vehicle controls such as AC or seats, and cloud ("Hey Lexus, show me fuel prices nearby").



POWERING THE DREAM

In the 1990s, thirsty engines were the unchallenged norm for luxury cars. As the millennium turned, the world was waking up to global warming and the need to reduce emissions through electrification. A new drivetrain solution was required. And the first luxury carmaker to step up to the mark was Lexus.

With all key hybrid components developed and manufactured in-house, our electrified hybrids have proved themselves to be uniquely refined, exhilarating to drive and exceptionally durable.

Two decades on, our dream at Lexus of zero-emission luxury travel has long become a roadmap. With each electrified car we launch, the final destination edges ever closer.



A PIONEER AND LEADER IN LUXURY CAR ELECTRIFICATION. Since the launch of our first luxury sedan over 30 years ago, Lexus has become a synonym for exceptional design, quality and refinement. Perhaps most importantly, we're also a pioneer and leader in luxury car electrification. A company that never stops innovating and working to anticipate drivers' needs. It's this unique approach that resulted in the world's first luxury hybrid in 2005 - the RX 400h SUV.

SELF-CHARGING HYBRID, PLUG-IN HYBRID OR ALL-ELECTRIC. Today, Lexus offers six amazing self-charging hybrid models and the majority of premium hybrids on the road bear the Lexus badge. No other luxury carmaker can rival our experience in developing, building, servicing and recycling hybrids. Our self-charging hybrids do not require plugging in and are capable of driving in Electric Vehicle (EV) mode, using no fuel and generating zero emissions.

Spearheading our new 'Lexus Electrified' vision, we introduced the first all-electric Lexus, the UX 300e, in 2020. Marking the next chapter of electrification, the first Lexus Plug-in Hybrid, the NX 450h+, has now extended our electrified line-up even further, with a new dedicated electric vehicle platform to follow.

THE FUTURE IS 'LEXUS ELECTRIFIED'. Despite the success of our electrified range, resting on our laurels is not an option. Which is why, in 2021, we signalled a new era of electrification at Lexus with the launch of the LF-Z Electrified concept. Amazing to drive, this car advances the Lexus Driving Signature, through the application of advanced electrification technologies and a dedicated EV platform. Superior dynamic performance is achieved through the intelligent location of the battery, electric motors and DIRECT4 all-wheel drive.

This is just the beginning. By 2025, Lexus plans to introduce more than 10 new plug-in hybrids, self-charging hybrids and all-electric vehicles inspired by the LF-Z.



Discover more: www.lexus.eu/electrified



FEEL MORE RESPONSIBLE

PIONEERED BY LEXUS

FEEL THE POWER OF THE WORLD'S MOST ADVANCED HYBRID TECHNOLOGY

WHAT IS A LEXUS SELF-CHARGING HYBRID?

Combining the power of an ultra-smooth petrol engine with one or more advanced electric motors, Lexus Self-Charging Hybrids have always set the benchmark for electrification of luxury cars. For your convenience, Lexus hybrids charge themselves while you drive, slow down or brake, meaning you never have to plug them in or worry about battery range. Sit back and enjoy an amazing blend of power and control, content in the knowledge that your Lexus is more efficient and is producing considerably fewer emissions than any conventional engine.

WHAT IS A LEXUS PLUG-IN HYBRID?

Our breakthrough Lexus Plug-in technology allows you to enjoy up to 76 km (combined cycle, up to 98 km in the city) emissions-free driving in Electric Vehicle mode with amazing refinement and powerful acceleration from a single charge, carried out at home or on the go. But that is only half the story. The car's Lexus Self-Charging Hybrid powertrain then comes into its own, providing an unbeatably efficient drive in hybrid mode, with low fuel consumption and emissions, irrespective of how long your journey is. This compelling combination of powerful Self-Charging Hybrid performance with best-in-class electric range is the result of more than 15 years of Lexus leadership in electrification.

WHY IS ELECTRIFICATION IMPORTANT?

In order to curb greenhouse gases, and to reach our goal of becoming a zero emissions company by 2050, we believe that effective vehicle electrification is essential. Since the launch of the RX 400h in 2005, the world's first electrified luxury car, Lexus has taken the initiative in developing and promoting the widespread use of eco-friendly self-charging hybrids. As well as reducing the emissions of our cars, by 2050 we plan to achieve zero CO₂ emissions from all Lexus manufacturing plants and minimise their water usage.

WHAT IS IT LIKE TO OWN A LEXUS HYBRID?

We work hard to ensure your Lexus hybrid is a joy to drive and own. With over 500,000 Lexus hybrids on European roads today, all are built in a dedicated ultra-modern production plant in Japan to the exacting quality standards that consistently net Lexus hybrids reliability awards across the globe. Aside from the striking smoothness and refinement, you'll appreciate the substantially lower running costs - not just fuel, but reduced expenditure on brakes, tyres and other components, thanks to the regenerative braking and advanced power control systems.

Learn more: www.lexus.eu/hybrid



108 km

Charging



Time to Full Charge 2 h 30 min
Hold □: ×

As you enjoy your drive, it is the ingenious interplay between petrol engine and electric motors which gives a Lexus Self-Charging Hybrid its unique blend of efficiency and refinement.



ZERO EMISSIONS AT LOWER SPEEDS

When you start off and at lower speeds, the powerful front electric motor (and rear electric motor on All-Wheel Drive models) propels the NX 350h with electric power supplied by the battery. At this point your car is almost silent, uses no petrol and produces zero emissions.

NEAR SILENT AT CRUISING SPEEDS

Lexus Self-Charging Hybrids are quiet and relaxing to drive. At higher speeds, the ultra-smooth 2.5-litre petrol engine cuts in quietly and receives assistance from the electric motor(s) when required. With the engine running at optimal speed, surplus power can be used to charge the battery. Alongside low emissions and fuel consumption, this near perfect distribution of petrol and electric power also provides the extraordinary driving enjoyment which characterises the NX 350h.



RAPID LINEAR ACCELERATION

Lexus Self-Charging Hybrids are fun to drive. When you accelerate hard, the power of the electric motor(s) instantaneously supplements the NX's 2.5-litre petrol engine. Together they deliver a potent surge of torque, providing rapid linear acceleration precisely when you need it.

REGENERATIVE BRAKING, NO PLUGGING IN

When decelerating, coasting, or when you come to rest, the petrol engine often turns off silently, cutting emissions to zero. On braking, or when you take your foot off the accelerator, regenerative braking harnesses your car's kinetic energy (this is wasted in conventional cars). The NX 350h converts this into electrical energy for storage in the battery, together with power generated whilst driving at higher speeds.



Our new Lexus Plug-in Hybrid drivetrain combines the advantages of 4th generation Lexus Self-Charging Hybrid and Lexus Electric Vehicle (EV) technology. The 'plus' in the NX 450h+ name pays tribute to the car's extra-powerful lithium-ion battery and enormous range in EV mode.



69 - 76 KM RANGE IN EV MODE

The NX 450h+'s four-mode selector ensures your journey is always smooth and fun. The EV default setting maximizes battery use, allowing you to travel distances up to 76 km (combined cycle, up to 98 km in the city). Powered by an advanced 18.1 kWh lithium-ion battery, you can enjoy near-silent and zero emissions driving up to 135 km/h.

ACCELERATION ON DEMAND

In Auto EV/Hybrid mode, and depending on how hard you depress the accelerator, the powerful petrol engine will spring to life and deliver rapid linear acceleration just when you need it, letting you reach 100 km/h in a mere 6.3 seconds.

EXPERIENCE FROM 2 MILLION HYBRIDS

Benefiting from our 4th generation Lexus Self-Charging Hybrid technology, if the battery's charge level drops while in EV or Auto EV/Hybrid mode, the system will switch to ultra-efficient Hybrid mode, letting you enjoy full vehicle power again.



CHARGES ON THE GO

If you urgently need to charge your battery, for instance to enter a zero emissions zone, you can use the Battery Charging mode to top it up.



PLUG IN AT HOME OR AWAY

For maximum EV range and performance, top up the battery at your own Lexus home charging station or at a public charging point. The Lexus Link app shows you the location, availability and even cost per km at stations across Europe.

THE ALL-NEW NX 350h

Giving you confidence in every driving situation, the NX 350h's potent new Lexus Self-Charging Hybrid drivetrain seamlessly orchestrates power from a 2.5-litre petrol engine and electric motor(s). Delivering 244 DIN hp, it boasts 25% more power and 15% faster acceleration compared to the previous NX. And because the system recharges as you drive, coast or brake, you'll also always enjoy exceptional range.



THE ALL-NEW NX 450h+

The NX 450h+ Lexus Plug-in Hybrid raises the bar for a 'no compromise' electrified vehicle. Delivering 309 DIN hp of power, it realises peerless quietness and overall CO₂ emissions as low as 21 g/km. Acceleration is thrilling - 0-100 km/h in 6.3 seconds - thanks to a large-capacity plug-in hybrid system that combines a 2.5-litre petrol engine with a motor/generator and 18.1 kWh lithium-ion battery. Alongside a class-leading electric range of up to 76 km (combined cycle, up to 98 km in the city), the NX 450h+ can reach up to 135 km/h in EV mode.



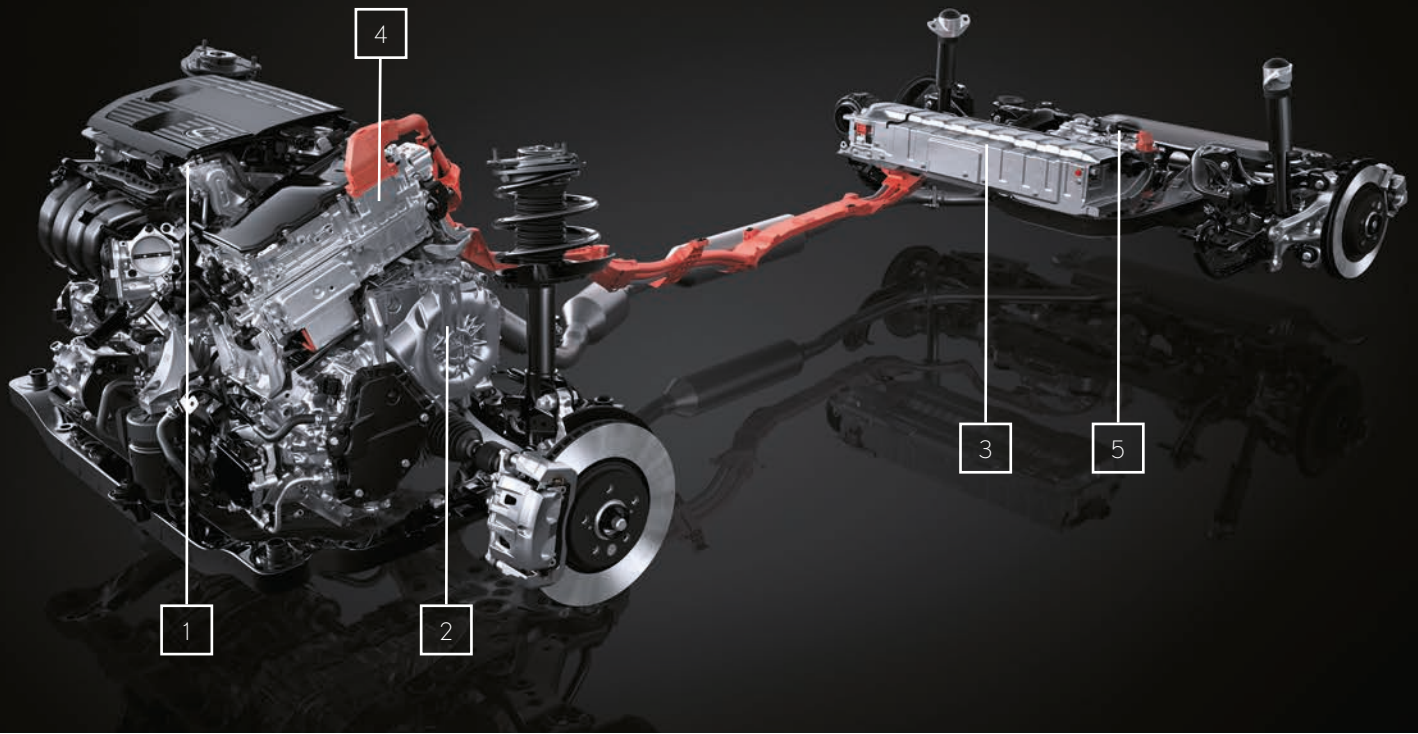

NX 350h | SELF-CHARGING HYBRID

01. 2.5-LITRE PETROL ENGINE

The NX 350h's all-new 2.5-litre petrol engine makes significant advances on its predecessor, achieving a world-class thermal efficiency of 41%. The new engine adopts the Atkinson Cycle, multi-hole D-4S direct and indirect fuel injection and electric VVT-iE for the intake. Importantly, CO₂ emissions are reduced by more than 18% to 127 g/km while maximum power is up to 192 DIN hp.

02. PRECISION-ENGINEERED TRANSAXLE

For an incredibly smooth yet responsive drive, the front electric motor, generator and power split mechanism are housed in one sophisticated hybrid transmission. Ultra-compact thanks to its multi-axial arrangement of motor/generator, it delivers the highest efficiency, quietness and performance in class.

03. LITHIUM-ION BATTERY

Newly developed for the NX 350h and installed under the rear seats, this high-performance lithium-ion battery contributes to both the spacious interior and excellent driving performance. Whilst its lightweight lithium-ion cells improve charging performance, its compactness and cooling system have been optimised.

04. POWER CONTROL UNIT (PCU)

Mounted directly above the transaxle, this compact new PCU enables a low-bonnet design which improves aerodynamics and reduces fuel consumption. Whilst compact dimensions and weight results from circuit board downsizing, the new unit features reduced power losses and enhanced cooling efficiency.

05. E-FOUR

The E-FOUR electric all-wheel drive system available on the new NX 350h and NX 450h+ has been upgraded so that the 54 DIN hp rear electric motor is always operational, providing more torque and greater traction.

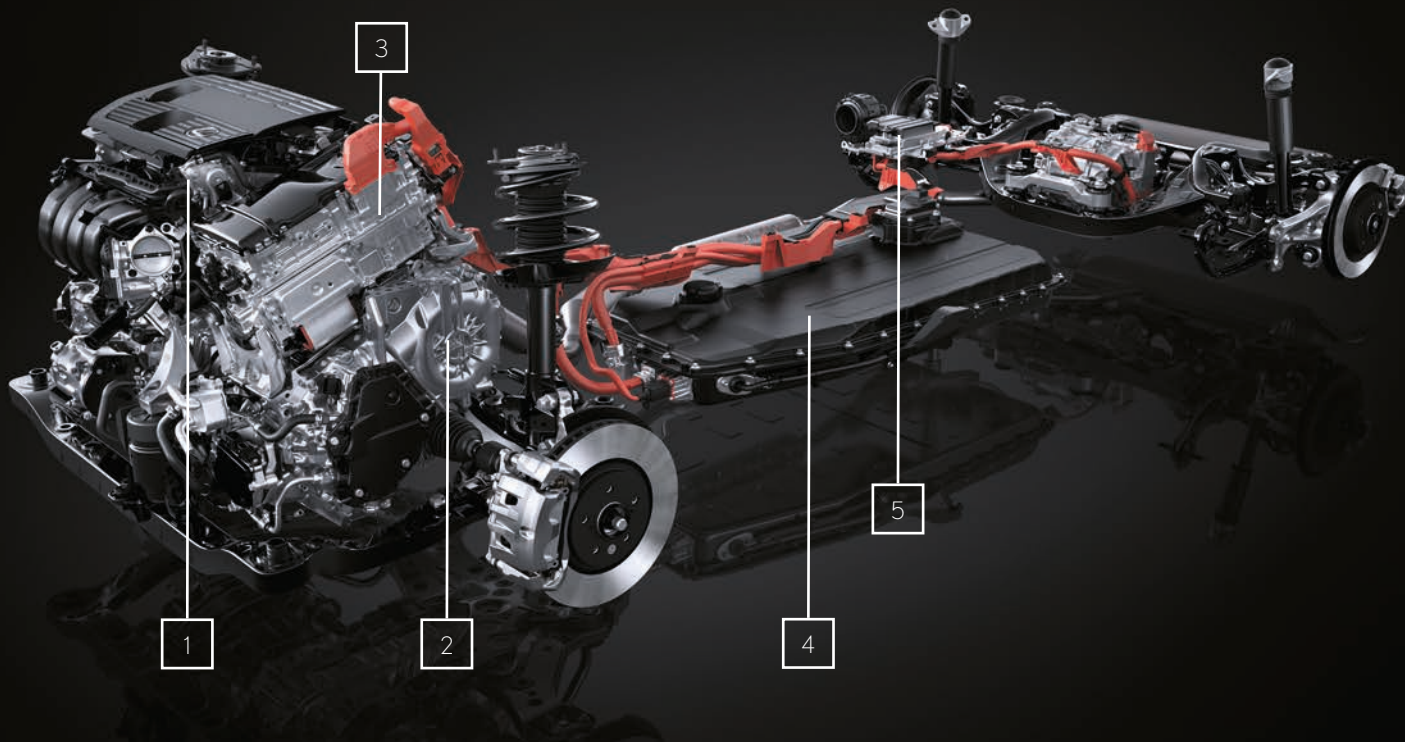

NX 450h+ | PLUG-IN HYBRID

01. 2.5-LITRE PETROL ENGINE

Using the same breakthrough engine as the NX 350h, the NX 450h+'s all-new 2.5-litre petrol powertrain also achieves a world-class thermal efficiency of 41%. And because this is a plug-in hybrid, overall CO₂ emissions are reduced to an incredibly low 21 g/km (depending on version).

02. PRECISION-ENGINEERED TRANSAXLE

The NX 450h+'s hybrid transaxle provides the lowest fuel consumption and highest driving performance in class. Comprising a super-smooth geartrain and 182 DIN hp motor/generator, it not only powers the front wheels, but produces electricity during braking, driving or coasting.

03. POWER CONTROL UNIT (PCU)

The new PCU is tailored to the high-capacity lithium-ion battery. With the DC/DC converter under the rear seat, a boost converter has been added, realizing higher output and compact size. Mounted directly above the transaxle to reduce bonnet height, an 8-layer structure houses the circuitry required for plug-in hybrid control.

04. LITHIUM-ION BATTERY

To allow for a spacious cabin, 554 litres of luggage space and a low centre of gravity, the powerful 18.1 kW lithium-ion battery is installed under the cabin floor. This new battery pack uses 96 high-capacity lithium-ion battery cells, achieving a class-leading range of between 69 and 76 km in EV mode (combined cycle, between 89 and 98 km in the city).

05. BATTERY COOLING / HEATING SYSTEM

Lexus engineers developed a sophisticated battery cooling system for the NX 450h+. Safer, more compact and lighter than water-cooled systems, refrigerant cools the battery, thus improving performance, efficiency and battery life. And because output decreases in cold weather, electric heaters are fitted under the battery stacks.

06. AC CHARGER PORT

In addition to an AC charging inlet on the right rear-quarter, the new NX 450h+ is fitted with an onboard charger with 6.6 kW maximum output.

COMFORT

18" alloy wheels, 15-spoke, machined finish, 235/60 R18 tyres

L-mesh signature grille with chrome garnish

Headlights, bi-LED with Automatic High Beam (AHB)

Fabric / Tahara trim with Micro Dot door inlays

Lexus Link Connect with 9.8" touchscreen display**

Lexus Link Cloud-based Navigation

10-speaker premium audio system



BUSINESS

18" alloy wheels, 15-spoke, machined finish, 235/60 R18 tyres

L-mesh signature grille with chrome garnish

Headlights, bi-LED with Automatic High Beam (AHB)

Tahara trim with 3D Black Prism door inlays

Lexus Link Connect with 9.8" touchscreen display**

Lexus Link Cloud-based Navigation

10-speaker premium audio system



EXECUTIVE*

- 20" alloy wheels, 5-twin-spoke design, 235/50 R20 extended mobility tyres
- L-mesh signature grille with chrome garnish
- Headlights, bi-LED with Automatic High Beam (AHB)
- Tahara trim with 3D Black Prism door inlays
- Safe Exit Assist (SEA)
- Lexus Link Pro with 14" touchscreen display**
- Lexus Link Pro Embedded Hybrid Navigation
- 10-speaker premium audio system



LUXURY*

- 20" alloy wheels, 20-spoke, machined finish, 235/50 R20 ext. mobility tyres
- L-mesh signature grille with chrome garnish
- Headlights, quad LED with Adaptive High-beam System (AHS)
- Leather upholstery with Sumi Black Walnut door inlays
- Safe Exit Assist (SEA)
- Lexus Link Pro with 14" touchscreen display**
- Lexus Link Pro Embedded Hybrid Navigation
- 17-speaker Mark Levinson® Premium Surround Sound System with PurePlay



* Options are shown.

** Premium Connectivity pack is included with Lexus Link Connect and Lexus Link Pro for the first 4 years of ownership, and renewable thereafter on a subscription basis.

F SPORT*

20" alloy wheels, F SPORT design, 235/50 R20 extended mobility tyres

F-mesh signature grille with black garnish

Headlights, quad LED with Adaptive High-beam System (AHS)

F SPORT leather upholstery with F Aluminium door inlays

Safe Exit Assist (SEA)

Lexus Link Pro with 14" touchscreen display**

Lexus Link Pro Embedded Hybrid Navigation

10-speaker premium audio system



* Options are shown.

** Premium Connectivity pack is included with Lexus Link Connect and Lexus Link Pro for the first 4 years of ownership, and renewable thereafter on a subscription basis.



01



02



03



04



05

01. F SPORT DESIGN

A bolder Lexus signature grille with an exclusive mesh pattern accentuates the new NX F SPORT's dynamic looks, which are further emphasised by details such as the striking black door mirrors, bespoke front and rear bumper spoilers, dark chrome side window frame mouldings and black roof rails. The F SPORT badge incorporates the curves of the iconic Fuji Speedway.

02. 20" F SPORT ALLOYS

Exclusive to F SPORT models and finished in Piano Black paint, these distinctive 5-twin-spoke alloy wheels underline the car's dynamic character.

03. F SPORT SEATS

With bespoke leather upholstery colours such as Black, Flare Red and White, alongside the Takumi-crafted aluminium ornamentation, the F SPORT interior is instantly arresting.

04. F SPORT COCKPIT

A dedicated 7-inch F SPORT central display perfectly complements the beautifully crafted F SPORT steering wheel that was developed with our 'Takumi' master drivers and features a shape specifically suited to sports driving. Finished in perforated leather, the gearshift design matches the steering wheel to create a united look. Drilled aluminium pedals and scuff plates add further excitement to the interior.

05. ADAPTIVE VARIABLE SUSPENSION / PERFORMANCE DAMPERS

Specially tuned to enhance drivability and handling around fast corners, Adaptive Variable Suspension (AVS) controls the damping force on all four wheels. This new system offers excellent damping force adjustment and an expanded damping range, meaning enhanced ride comfort on more kinds of road and an assured feel. Completing the dynamic package, NX F SPORT models are fitted with front and rear performance dampers.



01



02



03



04



05



06

01. DISTINCTIVE DARK-GREY 18" ALLOY WHEELS

Sporting a dark-grey metallic coating with machined details, this distinctive new 5-twin-spoke design adds real flair to the new NX.

02. DISCREET DARK-GREY 20" ALLOY WHEELS

The discreet dark-grey metallic finish perfectly complements this bold new 5-twin-spoke 20" wheel.

03. STRIKING DARK-GREY 20" ALLOY WHEELS

Standard on Luxury grades, this 5-twin-spoke wheel, with a striking dark-grey metallic coating and machined details, endows the new NX with a look of unmistakable distinction.

04. NEW SIGNATURE GRILLE

For the latest NX, our designers were determined to create a powerful new look. A more dynamic grille, with an integrated frame, has been developed. As well as contributing to weight reduction, the new design emphasises the car's dynamic impression. For an intriguing mesh pattern, slender U-shaped components were sculpted. Finally, the vertical design of the grille, in combination with triple slits at the bottom, provides enhanced cooling performance.

05. E-LATCH

Inspired by the grace of Japanese Shoji doors, the new NX's E-Latch switch-activated door release system allows your door to open in one smooth movement.

06. POWER TAILGATE

An exceptionally fast and responsive remote-controlled tailgate ensures convenience, especially when your arms are full of shopping. With the key in your pocket or bag, simply place your foot under the rear bumper to open or close the tailgate.



07



08



09/10



11



12

07. BI-LED / FULL DRL

These exquisitely crafted lights combine an L-shaped DRL (Daytime Running Light) with a single Bi-Beam LED unit, creating a sharp look with a resolute expression in a simple design.

08. QUADRUPLE LED BEAMS / FULL DRL

These stunning 4-projector LED headlights feature a black surround that conveys a highly distinctive impression. The light is highlighted by the Lexus Signature L-shaped DRL.

09. LEXUS SIGNATURE BLADE LIGHT

To the rear, a stylish new Lexus signature blade light, with a distinctive L-shaped lighting design, spans the entire width of the new NX.

10. NEW LEXUS LOGO

Creating a modern and easily recognisable new look, the redesigned LEXUS logo is located at the centre of the vehicle and the model logo on the lower right.

11. SUNROOF

An electric, tilt and slide glass sunroof adds a feeling of freedom, spaciousness and light to the new NX.

12. PANORAMIC ROOF

Available in combination with roof rails, the impressive glass roof is now openable too. Providing both extra headroom and sunshine in the cabin, it is fitted with an electric sliding blind to counter intense sunlight.



01/02



03



04

01. TAZUNA COCKPIT

The striking 'Tazuna' concept that was first showcased on the LF-30 design study has been introduced on the new NX. Created to deliver an exhilarating driving experience by maximizing your contact with the road ahead and steering wheel in your hands, the NX cockpit was inspired by the way riders are connected to their horses through reins (Tazuna).

02. ERGONOMIC DESIGN

While a prominent cockpit feature is the large 14" touchscreen display, concentration on the road ahead is paramount. With this in mind, Lexus interior designers developed near-perfect ergonomics where every control is precisely positioned to minimise driver distraction. Frequently used features like audio volume, temperature controls and defroster were given physical switches. For more focus, driving-related functions such as the Power button, Drive Mode Select, and gearshift are arranged around the driver and in comfortable reach.

03. LEXUS 'OMOTENASHI' WELCOME

As you open the driver's door, the NX's instruments display the vehicle silhouette and welcome you by name. When you depress the brake pedal, the Power button begins to gently pulsate, then the cockpit comes to life with graphics and sounds coordinated across the instruments, and the Head-Up Display and 14" screen direct your attention on the road ahead. Welcome to the new NX.

04. AMBIENT MOOD SELECTOR

With the new Lexus Mood Select feature, you can tailor the NX's ambient lighting to your own mood, from a palette of 64 colours. Based on our L-finesse design philosophy, Lexus interior designers have developed fourteen colours that express the ephemeral emotions and feelings felt when witnessing beautiful natural phenomena. The colours aim to provide a spirit of 'Omotenashi' hospitality and include themes such as:

- Healing: Serene hues create a 'healing' space in which the energy of the green natural world and the power and dynamism of life coexist
- Relaxing: Warm hues create a 'relaxing' space full of vitality, resonating with the momentary transitions of the sunlight and the heartbeat of the earth
- Arousing: White tones create an 'arousing' space in which invigorating sunlight through the day smoothly awakens the mind
- Focusing: Mystical cool hues create a 'focusing' space for the mind, evoking the passage of time and transient states of the natural world
- Exhilarating: Pure fire-like tones create an 'exhilarating' space for the driver, evoking the process of a flame changing temperature



05



06



07



08

05. NEWLY DESIGNED SEATS

The front seats in the new NX have been redesigned to offer top-class accessibility and controllability, as well as excellent support and comforts like heating and ventilation. In order to provide proper ergonomic support around the waist, a concave shape was created in the seat sides, reducing elbow contact when using the steering wheel and shift lever or using the console lid. Finally, seat side height was kept low to ensure excellent ingress and egress characteristics.

06. FLEXIBLE SPACE

A practical 60:40 split folding rear seat comes standard on all new NX models, which allows easy stowage of larger items like racing bikes or surfboards. With all rear seats folded down there is room to carry bulky objects.

07. S-FLOW CLIMATE CONTROL

S-Flow intelligently controls the interior climate according to ambient conditions, ensuring excellent fuel economy and optimal comfort for each passenger.

08. SCULPTED STEERING WHEEL

As the steering wheel and gearshift can significantly affect the driving experience, designers worked together with a Lexus 'Takumi' to thoroughly refine these points of contact. For the steering wheel, special focus was placed on the shape and cross-section to give an excellent feel and enhanced steering stability. The thumb rests and touch-sensitive switches were also redesigned.



01



02



03



04



05



06

01. LEXUS LINK MULTIMEDIA

Much faster and easier to use, with improved resolution on both the 9.8" (Lexus Link Connect with cloud navigation) and large 14" touchscreens (Lexus Link Pro with embedded hybrid navigation), Lexus Link Multimedia is the first system of its kind to use cloud navigation to regularly update your maps and traffic data.

02. EXTRA LARGE 14" TOUCHSCREEN

Perfectly positioned for relaxing interaction while you drive, this 14" High Definition touchscreen is one of the largest available in this category of car and allows you to access information like navigation, audio and climate control.

03. LEXUS VOICE ASSISTANT

Artificial Intelligence and the cloud work together in the clever Lexus Voice Assistant, which spares you grappling with buttons while you're concentrating on the road ahead. This newly developed "Hey Lexus" voice assistant understands natural language and the context of statements such as "I'm hungry" or "I'm cold" and can even recognise which front passenger is speaking. You can also customise your trigger name or ask the Lexus Voice Assistant to perform tasks like opening a window.

04. ONLINE SERVICES

To enhance your driving experience, web services such as online traffic, on-street & off-street parking real-time availability, weather forecasts and access to your web browser are all provided

05. "OVER-THE-AIR" UPDATES

Connected services and other software on the new NX are regularly updated using "Over The Air" (OTA) technology, meaning you'll always have the latest connected experience.

06. SMARTPHONE INTEGRATION

With Android Auto® or wireless Apple CarPlay®, the new NX allows you to easily display and access many of your smartphone's apps on the 9.8" or 14" display.



07

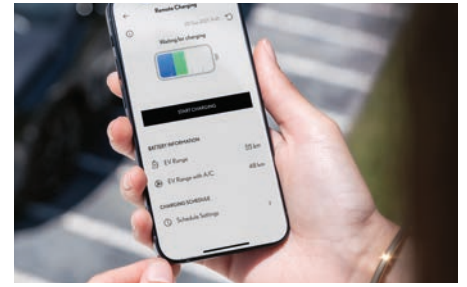

08



09

07. LEXUS LINK CONNECTED SERVICES

Welcome to the Lexus Link app, a new world of connectivity created to complement our unique 'Omotenashi' service experience. Its smart and bespoke features help you plan a journey, find a parking space, schedule a service or even improve your driving style. Transform your time with the new NX, using services like:

- Driving Analytics: Tracks your journeys, driving style and lets you record business trips
- Hybrid Coach: Helps you drive your NX 350h more efficiently
- Find my Car: Locates and guides you back to your Lexus
- Share to Car¹: Lets you plan a route on another device and send it to your Lexus, while 'Car to Door' guides you on foot to your final destination
- eCare: Lets you manage the service and maintenance of your NX
- Warning Lights: Explains the meaning of each warning light and any action you should take
- Car status: Notifies you if you've left the car windows open or forgotten to switch off the headlights. You can also check if your car is locked
- Battery Guard: Monitors the charge level of your car's 12V battery
- Remote Control: Remotely defrost your windscreen, activate hazard warning lights or lock and unlock your NX, from the comfort of your home

08. LEXUS LINK CONNECTED SERVICES FOR THE NX 450h+

For a seamless electrified experience, you can monitor the charge level and range of your NX 450h+ remotely, on your mobile. If you subscribe to the Lexus Charging solution, Lexus Link also locates charging stations across Europe, allowing you to check availability, charging speed and price and offers services like:

- Remote control and scheduling of charging
- Access to extensive European network of public charging facilities. Lets you check charging station availability, charging speed and price per kWh

09. LEXUS LINK PREMIUM CONNECTIVITY

As an NX owner, you'll get the all benefits of Lexus Link Standard Connectivity free of charge over the entire lifetime of your car. The Lexus Link Premium Connectivity pack is also free for the first 4 years of ownership, and thereafter on a subscription basis. It includes pioneering features such as:

- Cloud-based navigation & Voice Assistant
- Road Events & Real Time Traffic information
- On- and off-street parking availability
- Remote Climate²: All NX models offer remote control of air conditioning, steering wheel heating, seat heating and adjustment of the cabin temperature

¹Features are shown here for illustration purpose only. Please consult your Lexus retailer information on which are available in your Country and for your car model.

²Remote climate control features may not be available in your area based on local legislation. Please consult your Lexus retailer information on which are available in your Country and for your car model



01



02

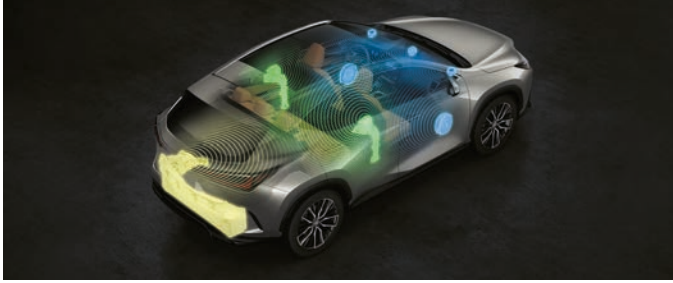

03



04

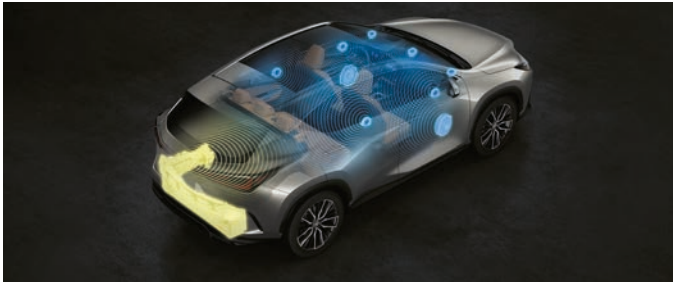

05



06

01. CABIN SOUND DESIGN

The near silent NX cabin provides an exquisitely crafted environment for a bespoke new range of Lexus sounds. The sounds are the fruits of jazz musician and music producer Jiro Yoshida working together with the Lexus 'Takumi' craftspeople.

02. MULTI-INFORMATION DISPLAY

This 7-inch colour TFT (Thin Film Transistor) display is integrated into the main driving instruments and keeps you informed about all key data including safety warnings and navigation directions. For a more dynamic and engaging experience, the display will also adjust its look and content depending on whether you are in Normal, Eco and Sport mode.

03. 10-SPEAKER PREMIUM AUDIO

A 10-speaker premium audio system is fitted as standard on all grades. This features an FM RDS tuner, Digital Audio Broadcasting and Bluetooth connectivity and offers greater fidelity with large speakers in the front doors.

04. EXTRA-WIDE 10" HEAD-UP DISPLAY

Vehicle data is projected in colour directly onto the windscreen. This larger 10" Head-Up Display lets you check navigation, safety features, car information and audio settings without taking your eyes off the road ahead. Its operation is seamless, thanks to touch switches on the steering wheel.

05. 17-SPEAKER MARK LEVINSON® SOUND

Available on NX 350h Luxury and F SPORT grades, the new 17-speaker Mark Levinson® Premium Surround system is tailored to the acoustic properties of the NX. It delivers a peerless 7.1-channel digital home-theatre experience enhanced by Clari-Fi™ that rebuilds sound lost in MP3 digital compression. For improved sound, the large 25 cm rear subwoofer is concealed in a 20-litre compartment below the luggage deck, rather like a speaker of a home hi-fi system, with no compromise to boot space.

06. WIRELESS CHARGER / 4 X USB SOCKETS

You can charge compatible smartphones or other electronic devices using the inductive wireless battery charger. 50% faster than before, it is conveniently positioned, with a handy storage compartment underneath. To keep your devices charged and connected, the NX features four USB sockets (Front: 1x A-type + 1x C-type, Rear: 2x C-type).



10:47

LTE

Back

Like Sugar Radio

Jungle Boogie
Kool & The Gang · Wild And Peaceful

Rock Steady
Aretha Franklin · Young, Gifted and Black

The Ghetto
Donny Hathaway · Everything Is Everything

It's My House - 12" Remix

A/C

21

90



01

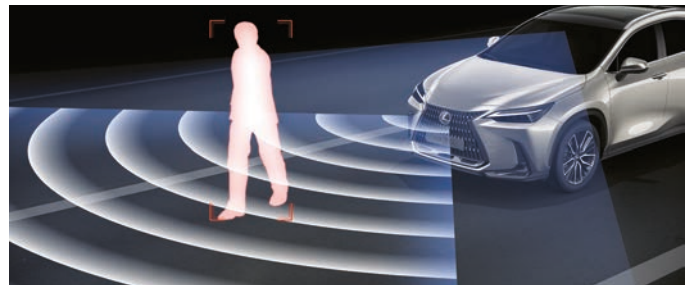

02

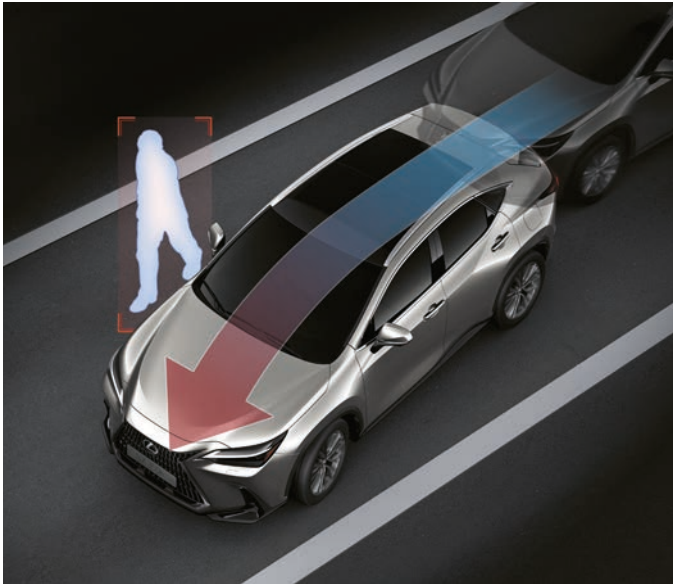

03



04



05

01. LEXUS SAFETY SYSTEM +

All new NX models are equipped with our latest Lexus Safety System + that is faster, covers 36% more accident cases, feels more natural to use and includes the following features:

02. PRE-COLLISION SYSTEM

As well as detecting cyclists during daytime and pedestrians at night, the new Pre-Collision system can now detect cyclists at night and will help prevent collisions at junctions and with oncoming vehicles and pedestrians. If the system judges that the possibility of a collision is high, the brakes are automatically applied to support collision avoidance, or reduce damage in the event of a collision.

03. EMERGENCY STEERING ASSIST

When a pedestrian is very close to or in your path of travel, Emergency Steering Assist on the new NX will support your steering movements to enhance the car's stability and prevent accidental lane departure.

04. DYNAMIC RADAR CRUISE CONTROL

The system uses the millimetre-wave radar sensor and a camera to detect the vehicle in front and maintain an appropriate distance. If the vehicle in front comes to a halt, the NX will stop too. When the vehicle moves off again, the NX will start off again. This system now features earlier detection of vehicles cutting in and automatically adjusts speed around bends. Dynamic Radar Cruise Control will also prevent you from driving inside a slower vehicle in the outside lane. And when following a slower vehicle, preliminary acceleration will be applied when you indicate to overtake. When changing into a lane where there is a slow vehicle in front, preliminary deceleration will be applied.

05. ROAD SIGN ASSIST

The upgraded Road Sign Assist (RSA) recognises traffic signs and stop signs, and provides information to the driver via the multi-information display. When linked to Dynamic Radar Cruise Control, the car's speed can be adjusted according to the speed limit recognised by RSA.



06

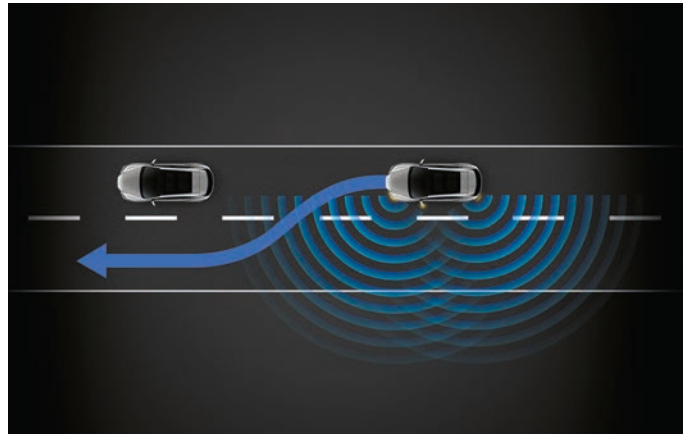

07

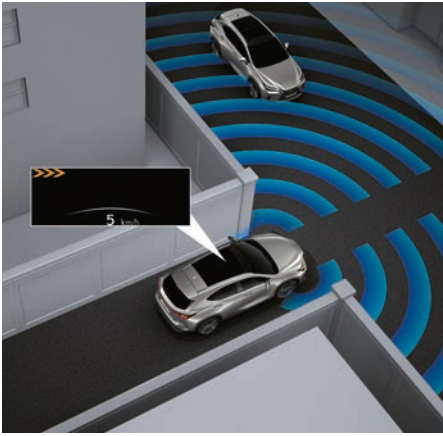

08



09



10

06. LANE TRACE ASSIST

The upgraded Lane Trace Assist helps keep the new NX in the centre of the lane using 'lane centring' and 'natural lane trace' functionality. With improved curve management, it also provides assistance when driving around bends.

07. LANE CHANGE ASSIST

On motorways, with activation of the turning signal as a cue, this new feature allows the NX to perform a driver-initiated lane change using Dynamic Radar Cruise Control. Monitoring the road environment, it controls steering, acceleration and deceleration.

08. FRONT CROSS TRAFFIC ALERT

The system assists in making driving safer at intersections by detecting approaching vehicles from left or right which might be hidden in blind spots and warns the driver via the Head-Up Display and the central multimedia display.

09. AUTOMATIC HIGH BEAM

Automatic High Beam detects oncoming vehicles at night and automatically dips the high beam headlights, reducing the danger of accidentally dazzling other drivers and allowing you concentrate on the road ahead.

10. ADAPTIVE HIGH-BEAM SYSTEM

On F SPORT and Luxury models, the Adaptive High-beam System also prevents the new NX from dazzling other road users. Independent LED chips in the headlights are enabled/disabled for precise control of the illuminated and non-illuminated areas



01



02

01. 8 AIRBAGS

In addition to an immensely strong passenger safety cell, occupant protection is enhanced by eight advanced airbags: Dual-stage airbag and knee airbag for the driver; Single-stage airbag for the front passenger; Centre airbag to reduce contact between the driver and front passenger; Side airbags on the front seats and Curtain shield airbags that run the full length of both cabin sides.

02. WHIPLASH INJURY LESSENING SEATS

The front seats are designed to minimise whiplash-inducing neck motion in a rear impact. Reinforced seat frames allow the torso to sink into the seatback, while the placement of the headrest supports the head more effectively.



03



04

03. DIGITAL PANORAMIC VIEW MONITOR

For easier driving in confined spaces, the Digital Panoramic View Monitor provides a live 360 view around and pre-recorded view under the car. It also creates a virtual 3D image of your NX, showing the vehicle as if seen from above, with on-screen guides to assist close-quarter manoeuvring and offers the following features:

- Side Clearance View lets you check the clearance when passing another vehicle on a narrow road.
- Cornering View helps avoid mounting curbs when cornering.
- Front Cross Traffic Alert warns of approaching vehicles and obstacles at the front and sides of the car.
- Pre-Collision System & Parking Support Brake warns of a possible collision and will even take preventive action.
- A view under the NX helps you drive on rougher surfaces.

04. DIGITAL INTERIOR REAR-VIEW MIRROR

The Digital Rear-View Mirror displays images from a camera at the rear of the car. This 2nd generation system features a lighter bezel, wider view and reduced blind spots. It also enhances your view when the rear seats are occupied, the luggage space is loaded to the roof, or weather and visibility are poor.



05



06



07



08



09

05. BLIND SPOT MONITOR

Blind Spot Monitor detects vehicles in adjacent lanes that are not visible in the door mirrors up to 60 metres behind your NX. If the driver indicates to change lane and a vehicle enters the blind spot, a warning signal appears in the relevant door mirror.

06. AUTOMATIC REAR FLASHING HAZARD LIGHTS

If Blind Spot Monitor detects vehicles approaching from behind in the same lane and judges the possibility of a rear-end collision is high, the system may alert the approaching vehicle by flashing your hazard lights at high speed for approximately two seconds.

07. REAR CROSS TRAFFIC ALERT

Rear Cross Traffic Alert helps avoid parking collisions during low-speed reversing. The system monitors the area at the rear of the NX and adjusts speed if it judges there is a possibility of contact with a vehicle. When necessary, the system alerts you with a buzzer, a warning on the 14" display and door mirrors, and will even brake if required.

08. SAFE EXIT ASSIST

Safe Exit Assist uses Blind Spot Monitor to track traffic such as cars or cyclists approaching from behind and where necessary keeps the door(s) closed, thus reducing door-opening accidents by up to 95%.

09. ADVANCED PARK SYSTEM

This Lexus breakthrough enables smooth and trouble-free automatic parking. With cameras and sensors tracking other cars and white lines, the fully automated Advanced Park system will recognise free parking spaces. At the touch of a button, the system automatically controls acceleration, steering, gear shifts and braking. Our engineers even deliberately incorporated human-like driving styles so that automated parking feels more 'natural' to you and your passengers.

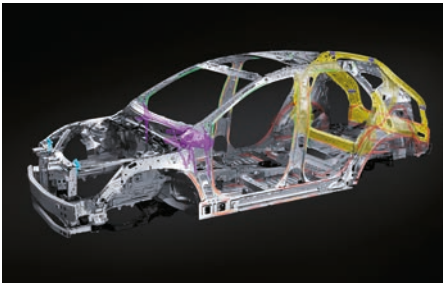

01



02



03

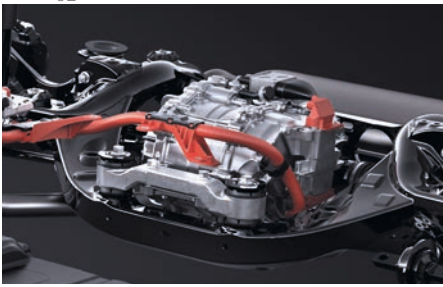

04



05



06

01. EXTREMELY STRONG NEW PLATFORM

Built on our much-acclaimed Global Architecture K-platform, the NX delivers many dynamic improvements, including enhanced grip and responsiveness. A wider tread and a lower centre of gravity result in superb handling and stability. In search of refinement and reduced understeer, Lexus engineers specified laser screw welding, adhesive bonding, roof reinforcements, twin bonnet locks and high-tensile steel strengthening. To save weight, aluminium was used for the wings and bonnet. Finally, Lexus 'Takumi' drivers drove lap after lap at our brand-new Shimoyama test track to fine-tune the NX steering and brakes.

02. DRIVE MODE SELECT

Located near the steering wheel, Drive Mode Select allows drivers to choose between Eco, Normal and Sport modes, to maximise the car's efficiency, dynamism or refinement. As well as Eco and Normal, the new NX F SPORT features additional Custom, Sport S and Sport S+ modes.

03. ADVANCED AERODYNAMICS

The new NX boasts excellent aerodynamics, thanks to a near-flat underbody and extensive wind tunnel testing. To refine airflow even further, Lexus designers and engineers worked on the shape of the lower front spoiler, airflow in the wheel arches, the shape of the car's sides and the lower rear bumper. The result is even greater vehicle stability, with reduced noise and drag. Chief Designer Suga-san calls this 'Functional Beauty'.

04. E-FOUR

On All-Wheel Drive models, E-FOUR delivers seamless performance and confident traction over rougher terrain. The innovative E-FOUR drivetrain features the addition of a 54 DIN hp electric motor mounted on the rear axle, which supplies instant torque on demand.

05. BRAKE PEDAL DESIGN

The contact area for the driver's foot has been expanded by changing the shape of the brake pedal pad. Vibrations were also reduced, improving the sense of stability when the pedal is depressed.

06. HILL-START ASSIST CONTROL

Hill-start Assist Control maintains brake pressure to help prevent the NX from moving backwards when starting off on a slope. Hill-start Assist Control also minimises wheel-spin on slippery inclines.



01



02



03



04



05

01. ENTRY WALLBOX WITH CHARGING CABLE, 22 KW

One of the smallest of its kind, the 22 kW Entry Wallbox features an integrated charging cable and Type 2 plug for home and semi-public applications. Thanks to its extremely compact dimensions, it is the perfect indoor and outdoor solution for efficient PHEV charging.

02. CONNECTED WALLBOX WITH CHARGING SOCKET, 22 KW

Equipped with one Type 2 charging socket, the 22 kW Connected Wallbox is a smart charging solution for home and semi-public applications. Featuring LAN, WiFi and optional LTE, the integrated RFID module ensures fast and secure access. The Connected Wallbox is also prepared for use as a master unit and is suitable for multiple charge point applications.

03. CHARGING CABLE

When charging on the go, use this cable (available in 5 m, 7.5 m or 10 m lengths) to connect your NX to a public charging station.

04. CABLE STORAGE BAG

This practical storage bag keeps your charging cable in good condition and prevents it from getting tangled or cluttering your luggage space.

05. LEXUS GLOVE AND TOWEL SET

The Lexus glove and towel set allows for clean handling of the charging cable under different conditions (when the cable is dirty or it's raining outside) or when refuelling. While the towel serves to wipe the charging cable clean and dry, the gloves protect your hands and let you handle the fuel nozzle in a safe and hygienic manner. The set comes packed in a practical bag.



01



02



03



03



03

01. NX CHROME PACK

Eye-catching chrome detailing added to your front bumper. Contoured chrome side sills that integrate smoothly with the side of your car, creating a powerful low profile. The rear chrome garnish adds a subtle touch of pure sophistication.

02. NX SUV PACK

Always stylish, no matter how minor the detail. Take the front and rear skirts for example, an ideal combination of protection and style. They preserve the premium look by protecting the front and rear areas that are vulnerable to getting scratched.

03. NX PROTECTION PACK

Keep your Lexus NX in the best condition possible with accessories designed to protect it from everyday bumps, scrapes and grime in the interior:

- The rear bumper protection film is tough transparent self-adhesive film that helps protect the rear bumper paintwork against those small scrapes and scratches that can occur when loading or unloading the boot.
- The trunk liner with a special anti-slip surface pattern is designed to fit the trunk of your vehicle and provide protection against dirt and spills.
- Genuine textile floor mats in velour or needle felt material are tough, practical and easy to clean. The driver's mat has a special fixing to prevent slippage during use.



04



05



06



07



08



09

04. DETACHABLE TOWING HITCH

The vertical detachable towing hitch has a tough anticorrosion surface and is designed so that you can easily attach and remove the tow ball at your leisure.

05. ROOF RACK / SKI HOLDER

Easy to use ski holder for 4 pairs of skis or 2 snowboards. Your equipment is securely fastened between 2 rubber profiles.

06. CROSS BARS

The purposeful aluminium cross bars add extra carrying capacity and come with Lexus' quick attachment mechanism, meaning you can even combine these with additional carrying accessories.

07. PROTECTION FILMS

Lexus Paint Protection films provide durable, long lasting protection to the most vulnerable areas of the vehicle against everyday damage. They are highly transparent, protective films, virtually invisible when applied to a vehicle's paintwork.

08. 18" ALLOY WHEEL

A bold 10-spoke design with a machined finish and big personality. Like all Lexus alloys, it is precision engineered for strength and optimum drive balance.

09. 20" ALLOY WHEEL

The black machined finish and high performance 15-spoke design create an unmistakable look of urban sophistication.



A WORLD OF COLOUR

A UNIQUE PROCESS AT LEXUS PRODUCES COLOURS SO LUSTROUS THAT THEY APPEAR TO REACT TO CHANGING LIGHT CONDITIONS.

Lexus designers recognise the emotional pull of colour on a car. This explains why they never use off-the-shelf colours, but develop their own, in a process that can take two years. In fact, the same attention to detail that goes into sculpting the design of a Lexus is replicated in the care that goes into the paintwork that will best show off that design.

Around 30 unique colours make up the Lexus palette. These tones are arrived at only after the colour designers have discarded hundreds of others, a process requiring a trained eye and a mastery of chromogenics - the science of pigments and colour compounds.

Bending test panels to mimic car contours, designers scrutinise colours under floodlights, in sunlight and shade, and in different months of the year. Their expert eyes are uncanny in selecting the right tones to complement each model. In the case of the new NX, for example, Sonic Titanium is among the colours which perfectly accentuate the bold form of this luxury mid-size SUV.

Then there's the process of developing and applying that colour, from the lab technicians mixing the paint to the paint shop crew who ensure a flawless, uniform coat. And on to inspections where, under RGB lighting, imperfections as small as 0.5 mm are detected. By hand.

Lexus has developed a five-coat process which results in a level of depth and luminescence not possible with traditional paintwork. Between layers, the paintwork is gently wet-sanded by hand under the supervision of 'Takumi' master craftspeople, a painstaking process to ensure each fresh surface is blemish-free.

Even to the untrained eye, the evenness and glossiness of this paint is evident. Just watch as these colours appear to change as the light conditions change.

F WHITE | 083¹



SONIC WHITE | 085²



SONIC TITANIUM | 1J7



SONIC GREY | 1L1

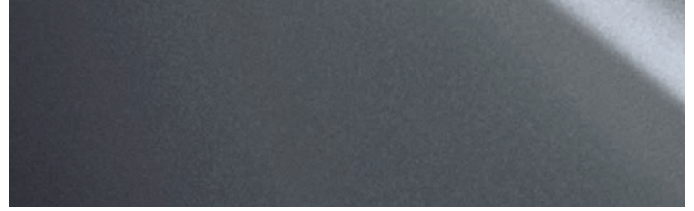

BLACK | 2I2³

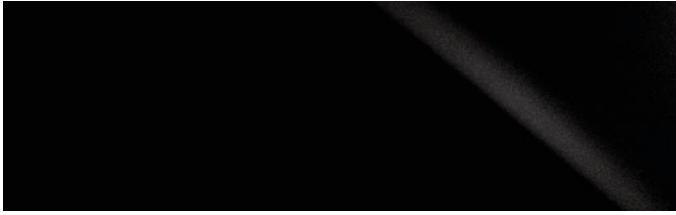

GRAPHITE BLACK | 223

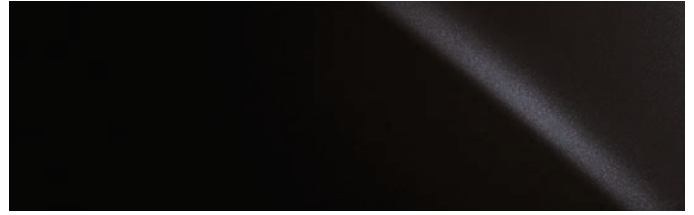

RED | 3T2³



TERRANE KHAKI | 6X4

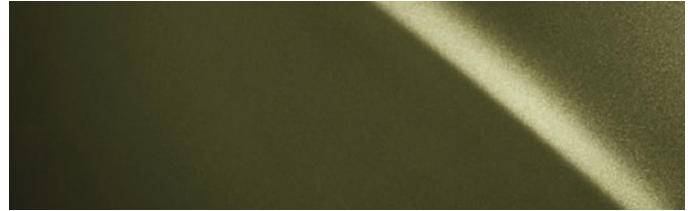

BLAZING CARNELIAN | 4Y1



CELESTIAL BLUE | 8Y6



SAPPHIRE BLUE | 8X1¹



¹Exclusive to F SPORT.

²Not available on F SPORT.

³Solid colour

Please note: due to printing variances, actual paintwork colours may vary slightly from those illustrated.



COLOURS | INTERIOR

FABRIC/TAHARA¹

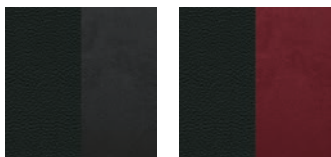

Black

Dark Rose

TAHARA TRIM²

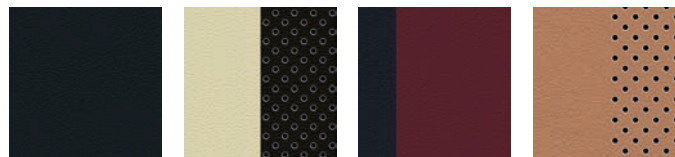

Black

Black and Rich Cream

Dark Rose

Hazel

LEATHER³

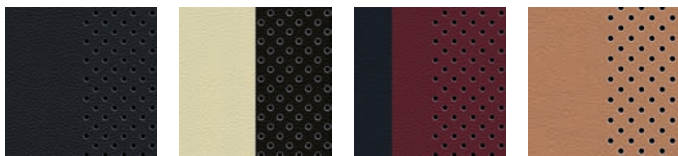

Black

Black and Rich Cream

Dark Rose

Hazel

FSPORT LEATHER⁴

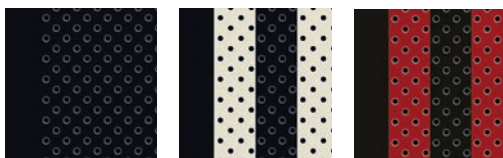

Black

White

Flare Red



COLOURS | INTERIOR

INLAYS⁵



Micro Dot



3D Black Prism

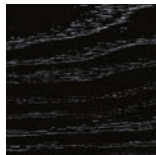

Sumi Black Walnut

F SPORT INLAYS⁶



F Aluminium

¹ Fabric/Tahara upholstery is standard on Comfort grade.

² Tahara trim is standard on Business and Executive grades.

³ Smooth leather is standard on Luxury grade. It is also available as part of the Interior Upgrade option pack on Executive grade.

⁴ F SPORT Smooth leather is a unique design and exclusive to F SPORT.

⁵ Micro Dot inlays are standard on Comfort grade. 3D Black Prism inlays are standard on Business and Executive grades. Sumi Black Walnut inlays are standard on Luxury grade.

⁶ F Aluminium inlays are standard on F SPORT.

Your local Lexus Authorised Retailer will be pleased to provide you with any further help.

EQUIPMENT | GRADES

EXTERIOR	COMFORT	BUSINESS	EXECUTIVE	F SPORT	LUXURY
L-mesh signature grille with chrome garnish	■	■	■	-	■
F-mesh signature grille with black garnish	-	-	-	■	-
Front bumper, F SPORT design	-	-	-	■	-
Rear bumper, F SPORT design	-	-	-	■	-
Headlights, bi-LED	■	■	■	-	-
Headlights, quad LED	-	-	□	■	■
Headlight cleaners	○	○	○	■	■
Auto-levelling headlights, static	■	■	■	-	-
Auto-levelling headlights, dynamic	-	-	□	■	■
Daytime running lights (DRL), LED	■	■	■	■	■
Front fog lights, LED	○	■	■	■	■
Cornering lights, LED	-	-	□	■	■
Rear foglights, LED	■	■	■	■	■
Front indicator lights, LED	-	-	□	■	■
Puddle lights	□	■	■	■	■
Acoustic glass, windscreen and front side glass	■	■	■	■	■
Dusk sensor	■	■	■	■	■
Rain sensing windscreen wipers	■	■	■	■	■
Privacy glass	-	○	■	■	■
F SPORT badge, front wings	-	-	-	■	-
Black roof rails	-	-	-	■	-
Black outer mirror cover	-	-	-	■	-
Black stainless steel moulding, side windows frame	-	-	-	■	-
Driver's door mirror, electro chromatic (auto-dimming)	■	■	■	■	■
Door mirrors, electrically adjustable, auto-folding, heated	■	■	■	■	■
6.6kW AC charger with Type 2/Mennekes inlet	-	-	-/■	-/■	-/■
Household charging cable ¹	-	-	-/○	-/○	-/○
Intelligent parking assist sensors, front and rear	○	■	■	■	■
WHEELS					
18" alloy wheels, 15-spoke, machined finish, 235/60 R18 tyres	■	■	■	-	-
20" alloy wheels, 5-twin-spoke design, 235/50 R20 extended mobility tyres	-	-	○	-	-
20" alloy wheels, F SPORT design, 235/50 R20 extended mobility tyres	-	-	-	■	-
20" alloy wheels, Black F SPORT design, 235/50 R20 extended mobility tyres	-	-	-	○	-
20" alloy wheels, 20-spoke, machined finish, 235/50 R20 extended mobility tyres	-	-	-	-	■

ACTIVE SAFETY AND DRIVING DYNAMICS	COMFORT	BUSINESS	EXECUTIVE	F SPORT	LUXURY
Acoustic Vehicle Alerting System (AVAS)	■	■	■	■	■
Active brake lights	■	■	■	■	■
Adaptive High-beam System (AHS)	-	-	□	■	■
Adaptive Variable Suspension (AVS)	-	-	-	■	-
Anti-lock Braking System (ABS)	■	■	■	■	■
Auto EV/Hybrid mode	-	-	-/■	-/■	-/■
Automatic Rear Flashing Hazard Lights (ARFHL)	-	□	■	■	■
Blind Spot Monitor (BSM) with Rear Cross Traffic Alert and Braking (RCTAB)	-	□	■	■	■
Drive Mode Select, Eco / Normal / Sport	■	■	■	-	■
Drive Mode Select, Eco / Normal / Custom / Sport S / Sport S+	-	-	-	■	-
Dynamic Radar Cruise Control (DRCC), all-speed	■	■	■	■	■
Electric Parking Brake (EPB)	■	■	■	■	■
Electric Power Steering (EPS)	■	■	■	■	■
Electronically Controlled Braking-Regeneration (ECB-R)	■	■	■	■	■
Emergency Steering Assist (ESA)	■	■	■	■	■
EV (Electric Vehicle) mode	■	■	■	■	■
Front and rear performance dampers	-	-	-	■	-
Front Cross Traffic Alert (FCTA)	-	-	□	□	□
Front cyclist detection	■	■	■	■	■
Front motorbike rider detection, daytime only	■	■	■	■	■
Front pedestrian detection	■	■	■	■	■
Advanced Park	-	-	-	-	○
Hill-start Assist Control (HAC)	■	■	■	■	■
Intersection Turn Assist (ITA)	■	■	■	■	■
Lane Change Assist (LCA)	-	-	□	□	□
Lane Tracing Assist (LTA)	■	■	■	■	■
Pre-Collision System (PCS)	■	■	■	■	■
Road Sign Assist (RSA)	■	■	■	■	■
Speed limiter linked to Road Sign Assist	■	■	■	■	■
Safe Exit Assist (SEA)	-	□	■	■	■
Traction Control (TRC)	■	■	■	■	■
Trail mode ²	■	■	■	■	■
Trailer Sway Control	■	■	■	■	■
Tyre Pressure Warning System (TPWS) with Auto location	■	■	■	■	■
Vehicle Stability Control (VSC)	■	■	■	■	■

- Available as standard.
- Available as an option.
- Available as part of a pack.
- Not available.

Where multiple availabilities are shown the first is for the NX 350h model, the second for the NX 450h+ model.

¹ The socket type available for the household charging cable may differ by market.

² Trail mode is available for NX 350h AWD and NX450h+ models only.

PASSIVE SAFETY	COMFORT	BUSINESS	EXECUTIVE	F SPORT	LUXURY
Dual-stage airbag, driver and single-stage airbag, front passenger	■	■	■	■	■
Front centre airbag	■	■	■	■	■
Knee airbag, driver	■	■	■	■	■
Curtain shield airbags	■	■	■	■	■
Side airbags, driver and front passenger	■	■	■	■	■
Airbag cut-off switch, front passenger	■	■	■	■	■
Audible and visual seatbelts reminder, front and rear seats	■	■	■	■	■
Seatbelt pre-tensioners, front and outer rear seats	■	■	■	■	■
i-Size attachment, outer rear seats	■	■	■	■	■
ISOFIX attachment, outer rear seats	■	■	■	■	■
SECURITY					
Anti-theft system - glass breakage sensor ¹	○	○	○	○	○
Anti-theft system - immobiliser	■	■	■	■	■
Anti-theft system - inclination sensor ¹	○	○	○	○	○
Anti-theft system - intrusion sensor ¹	■	■	■	■	■
Anti-theft system - siren ¹	■	■	■	■	■
Auto door locking	■	■	■	■	■
Double door lock	■	■	■	■	■
Wireless door lock	■	■	■	■	■

AUDIO, COMMUNICATION & INFORMATION	COMFORT	BUSINESS	EXECUTIVE	F SPORT	LUXURY
7" colour multi-information display	■	■	■	■	■
Digital speedometer	■	■	■	■	■
Head-Up Display (HUD)	–	–	□	■	■
Lexus Link Connect - 9.8" touchscreen display	■	■	■	–	–
Lexus Link Pro - 14" touchscreen display	□	□	□	■	■
Lexus Link Cloud-based Navigation ²	■	■	■	–	–
Lexus Link Pro Embedded Hybrid Navigation ²	□	□	□	■	■
Lexus Link Standard Connectivity	■	■	■	■	■
Lexus Link Premium Connectivity (4 years) ²	■	■	■	■	■
Bluetooth® mobile phone and audio connectivity	■	■	■	■	■
Smartphone integration (Wireless Apple CarPlay®, Android Auto®)	■	■	■	■	■
Wireless smartphone charger	○	○	○	○	■
10-speaker premium audio system	■	■	■	■	■
17-speaker Mark Levinson® Premium Surround Sound System with PurePlay	–	–	–	□/–	○/–
Digital Audio Broadcasting (DAB) radio	■	■	■	■	■
Antenna, shark fin design	■	■	■	■	■
2 USB ports, front centre console ³	■	■	■	■	■
2 USB ports, rear centre console ⁴	■	■	■	■	■
Emergency Response System (eCall)	■	■	■	■	■
Parking assist monitor with on-screen guides	■	■	■	■	■
Panoramic View Monitor (PVM) with rear pedestrian detection	–	–	□	○	■
Steering wheel mounted controls, audio / display / phone / voice / DRCC / LTA	■	■	■	–	–
Steering wheel mounted customizable touch controls	–	–	□	■	■

- Available as standard.
- Available as an option.
- Available as part of a pack.
- Not available.

Where multiple availabilities are shown the first is for the NX 350h model, the second for the NX 450h+ model.

¹ Anti-theft systems availability may differ by market.

² Premium Connectivity pack is included with Lexus Link Connect and Lexus Link Pro for the first 4 years of ownership, and renewable thereafter on a subscription basis.

³ Type-A USB port and Type-C USB charging port is fitted in the front center console.

⁴ Type-C USB charging ports are available in the rear centre console.

EQUIPMENT | GRADES

SEATS	COMFORT	BUSINESS	EXECUTIVE	F SPORT	LUXURY
Fabric/Tahara	■	-	-	-	-
Tahara trim	-	■	■	-	-
F SPORT leather upholstery	-	-	-	■	-
Leather upholstery	-	-	□	-	■
F SPORT exclusive front seats	-	-	-	■	-
Driving position memory (seat, steering wheel, outer mirrors) - 3 user profiles	-	-	□	■	■
Heated front seats	○	■	■	■	■
Ventilated front seats	-	-	□	■	■
6-way manually adjustable front seats	■	■	-	-	-
8-way electrically adjustable front seats	-	□	■	■	■
2-way lumbar support, driver seat	-	□	■	■	-
4-way lumbar support, driver seat	-	-	□	-	■
2-way manually adjustable front headrests	■	■	■	-	■
4-way manually adjustable front headrests	-	-	-	■	-
F SPORT logo embossed on front headrests	-	-	-	■	-
Heated outer rear seats	-	-	-/□	■	■
Manually folding rear seat backrest, 60/40 split	■	■	■	■	■
2-way manually adjustable rear headrests	■	■	■	■	■

INTERIOR COMFORT & CONVENIENCE	COMFORT	BUSINESS	EXECUTIVE	F SPORT	LUXURY
3-spoke, leather trimmed steering wheel	■	■	■	-	■
3-spoke, perforated leather trimmed steering wheel	-	-	-	■	-
Paddle-shift controls	■	■	■	■	■
Heated steering wheel	○	○	○/■	○/■	○/■
Steering column, manually multi-adjustable	■	■	■/-	-	-
Steering column, electrically multi-adjustable	□	□	□/■	■	■
Easy entry and exit function, steering wheel retracts/returns	□	□	□/■	■	■
Easy entry and exit function, driver seat retracts/returns	-	□	■	■	■
Illuminated entry system	■	■	■	■	■
Ambient lighting	-	■	■	-	-
Multi-colour ambient lighting (64 colours)	-	-	□	■	■
Digital rear-view mirror	-	-	-	○	○
Sunglasses holder, overhead front console	■	■	■	■	■
Glass sunroof, electric tilt/slide with manually operated sunroof blind	○	○	○	○	○
Panoramic glass sunroof, electric tilt/slide with electrically operated sunroof blind	-	○	○/-	○/-	○/-
Electrically operated windows with one-touch control	■	■	■	■	■
Automatic air recirculation control	■	■	■	■	■
Clean air filter with pollen removal and deodoriser	■	■	■	■	■
Electronic climate control, 2-zone	■	■	■	■	■
Humidity sensor for climate control	-	-	-/■	-/■	-/■
S-Flow technology for climate control	■	■	■	■	■
Lexus Climate Concierge	-	-	□	■	■
Front wiper de-icer ¹	○	○	○	○	○
Door inlays, Micro Dot	■	-	-	-	-
Door inlays, 3D Black Prism	-	■	■	-	-
Door inlays, F Aluminium	-	-	-	■	-
Door inlays, Sumi Black Walnut	-	-	-	-	■
Leather trimmed gearshift knob	■	■	■	-	■
Perforated leather trimmed gearshift knob	-	-	-	■	-
Machined aluminium sports pedals	-	-	-	■	-
Smart start system	■	-	-	-	-
Smart entry and start system	□	■	■	■	■
e-Latch door lock system	■	■	■	■	■
Card key	-	○	○	○	■
Stainless steel scuff plates with LEXUS inscription, front doors	■	■	■	-	■
F SPORT stainless steel scuff plates, front doors	-	-	-	■	-
Luggage cover, manually folding	■	■	■	■	■
Tyre repair kit ²	■	■	■	-	-
Tailgate, electric lift and close with height memory function	□	○	■	■	■
Tailgate, kick-open function	-	-	○/■	○/■	■

- Available as standard.
- Available as an option.
- Available as part of a pack.
- Not available.

Where multiple availabilities are shown the first is for the NX 350h model, the second for the NX 450h+ model.

¹Front wiper de-icer availability may differ by market.

²No tyre repair kit is provided when the optionally available 20" alloy wheels are selected with extended mobility tyres.

EQUIPMENT | PACKS

PACKS	COMFORT	BUSINESS	EXECUTIVE	F SPORT	LUXURY
Lexus Safety System+¹					
Headlights, bi-LED	■	■	■	-	-
Automatic High Beam (AHB)	■	■	■	-	-
Headlights, quad LED	-	-	□	■	■
Adaptive High-beam System (AHS)	-	-	□	■	■
Front indicator lights, LED	-	-	□	■	■
Cornering lights, LED	-	-	□	■	■
Headlight cleaners	○	○	○	■	■
Auto-levelling headlights, static	■	■	■	-	-
Auto-levelling headlights, dynamic	-	-	□	■	■
Pre-Collision System (PCS)	■	■	■	■	■
Front cyclist detection	■	■	■	■	■
Front motorbike rider detection, daytime only	■	■	■	■	■
Front pedestrian detection	■	■	■	■	■
Emergency Steering Assist (ESA)	■	■	■	■	■
Intersection Turn Assist (ITA)	■	■	■	■	■
Dynamic Radar Cruise Control (DRCC), all-speed	■	■	■	■	■
Speed limiter linked to Road Sign Assist	■	■	■	■	■
Lane Tracing Assist (LTA)	■	■	■	■	■
Road Sign Assist (RSA)	■	■	■	■	■
Front Cross Traffic Alert (FCTA)	-	-	□	□	□
Lane Change Assist (LCA)	-	-	□	□	□
Contents of the Lexus Link Pro pack	□	□	□	■	■
Smart entry pack					
Puddle lights	□	■	■	■	■
Smart entry and start system	□	■	■	■	■
Electrically operated tailgate					
Puddle lights	□	■	■	■	■
Smart entry and start system	□	■	■	■	■
Tailgate, electric lift and close with height memory function	□	○	■	■	■
Electrically operated seats pack					
8-way electrically adjustable front seats	-	□	■	■	■
Easy entry and exit function, driver seat retracts/returns	-	□	■	■	■
2-way lumbar support, driver seat	-	□	■	■	-
Cockpit upgrade pack					
Steering wheel mounted customizable touch controls	-	-	□	■	■
Head-Up Display (HUD)	-	-	□	■	■
Steering column, electrically multi-adjustable	□	□	□/■	■	■
Easy entry and exit function, steering wheel retracts/returns	□	□	□/■	■	■

PACKS	COMFORT	BUSINESS	EXECUTIVE	F SPORT	LUXURY
Interior upgrade pack					
Multi-colour ambient lighting (64 colours)	-	-	□	■	■
Driving position memory (seat, steering wheel, outer mirrors) - 3 user profiles	-	-	□	■	■
Leather upholstery	-	-	□	-	■
8-way electrically adjustable front seats	-	□	■	■	■
4-way lumbar support, driver seat	-	-	□	-	■
Heated outer rear seats	-	-	-/□	■	■
Ventilated front seats	-	-	□	■	■
Easy entry and exit function, steering wheel retracts/returns	□	□	□/■	■	■
Steering column, electrically multi-adjustable	□	□	□/■	■	■
Lexus Climate Concierge	-	-	□	■	■
Rear safety pack					
Blind Spot Monitor (BSM) with Rear Cross Traffic Alert and Braking (RCTAB)	-	□	■	■	■
Safe Exit Assist (SEA)	-	□	■	■	■
Automatic Rear Flashing Hazard Lights (ARFHL)	-	□	■	■	■
Lexus Link Pro pack					
Lexus Link Pro - 14" touchscreen display	□	□	□	■	■
Lexus Link Pro Embedded Hybrid Navigation ²	□	□	□	■	■
Steering column, electrically multi-adjustable	□	□	□/■	■	■
Easy entry and exit function, steering wheel retracts/returns	□	□	□/■	■	■
Panoramic view pack					
Contents of the Lexus Link Pro pack	-	-	-	-	-
Panoramic View Monitor (PVM) with rear pedestrian detection	-	-	□	○	■
Mark Levinson® Premium pack					
Panoramic View Monitor (PVM)	-	-	□	○	■
17-speaker Mark Levinson® Premium Surround Sound System with PurePlay	-	-	-	□/-	○/-

- Available as standard.
- Available as an option.
- Available as part of a pack.
- Not available.

Where multiple availabilities are shown the first is for the NX 350h model, the second for the NX 450h+ model.

¹ Do not use the Lexus Safety System + instead of normal driving under any circumstances and please read the instructions before operating the system. The driver is always responsible for driving safely.

² Premium Connectivity pack is included with Lexus Link Connect and Lexus Link Pro for the first 4 years of ownership, and renewable thereafter on a subscription basis.

TECHNICAL DATA

ENGINE	NX 350h AWD (FWD)	NX 450h+ AWD
Capacity (cm ³)	2487	2487
Cylinders / Valves	L4 / 16	L4 / 16
Maximum power (DIN hp @ rpm)	190 @ 6000	185 @ 6000
Maximum power (kW @ rpm)	140 @ 6000	136 @ 6000
Maximum torque (Nm @ rpm)	239 @ 4300 - 4500	227 @ 3200 - 3700
ELECTRIC MOTOR		
Type	AC synchronous, permanent magnet	AC synchronous, permanent magnet
Maximum power (DIN hp) - front/rear	182 / 54 (182 / -)	182 / 54
Maximum power (kW) - front/rear	134 / 40 (134 / -)	134 / 40
Maximum torque (Nm) - front/rear	270 / 121 (270 / -)	270 / 121
TRANSMISSION		
Type	Electronic-Continuously Variable Transmission	Electronic-Continuously Variable Transmission
Drive	E-FOUR (Front-Wheel Drive)	E-FOUR
TOTAL SYSTEM OUTPUT¹		
Total power (DIN hp)	244	309
Total power (kW)	179	227
CHARGING		
Battery type	Lithium ion	Lithium ion
Battery capacity (kWh)	n/a	18.1
Maximum charging power AC (kW)	-	6.6
Approx. 0 - 100% charging time AC (h : min)	-	from 2:30 to 9:00
PERFORMANCE		
Maximum speed (km/h)	200	200
Maximum EV speed (km/h)	125	135
Acceleration 0-100 km/h (s)	7.7 (8.7)	6.3
FUEL CONSUMPTION² (l/100 km)		
Combined	6.4 - 5.9 (5.9 - 5.6)	11 - 0.9
CO₂ EMISSIONS² (g/km)		
Combined	146 - 133 (133 - 127)	25 - 21
EV RANGE² (km)		
Combined	-	69-76
City	-	89-98
EMISSION STANDARD		
Euro Class	Euro 6d-ISC-FCM	Euro 6d-ISC-FCM
WEIGHTS (kg)		
Gross vehicle	2380 (2320)	2540
Kerb weight (min. - max.)	1790 - 1870 (1730 - 1810)	1990 - 2050
CAPACITIES³		
Luggage volume - rear seats upright, loaded to luggage cover (l)	549 / 554	549 / 554
Fuel tank capacity (l)	55	55
Towing capacity max. unbraked (kg)	750	750
Towing capacity max. braked (kg)	1500	1500

All figures listed are preliminary, tentative values subject to change without notice.

¹ Combined engine and electric motor.

² The electric range, electric energy, fuel consumption and CO₂ values are measured in a controlled environment on a representative production model, in accordance with the requirements of the new WLTP European Regulation EC 2017/1151 and its applicable amendments. For each individual vehicle configuration, the final electric range, electric energy, fuel consumption and CO₂ values may be calculated based on the ordered optional equipment. The electric range, electric energy, fuel consumption and CO₂ values of your vehicle may vary from those measured or calculated values, as driving behaviour as well as other factors (such as road conditions, traffic, vehicle condition, tyre pressure, load, number of passengers, etc.) have an influence on a car's electric range, electric energy, fuel consumption and CO₂ emissions. For more information regarding the new WLTP test method, please visit: www.lexus.eu/wltp#nedc

³ Luggage volume is calculated as per the VDA method. All figures quoted include the under-floor storage area in the luggage compartment. The first figure applies when equipped with a Tyre repair kit, the second figure applies for models with 20" alloy wheels and extended mobility tyres. Towing capacity does not include towbar or other towing equipment as standard.

Please note: further Technical Data, including any updates, can be found at www.lexus.eu

TECHNICAL DATA

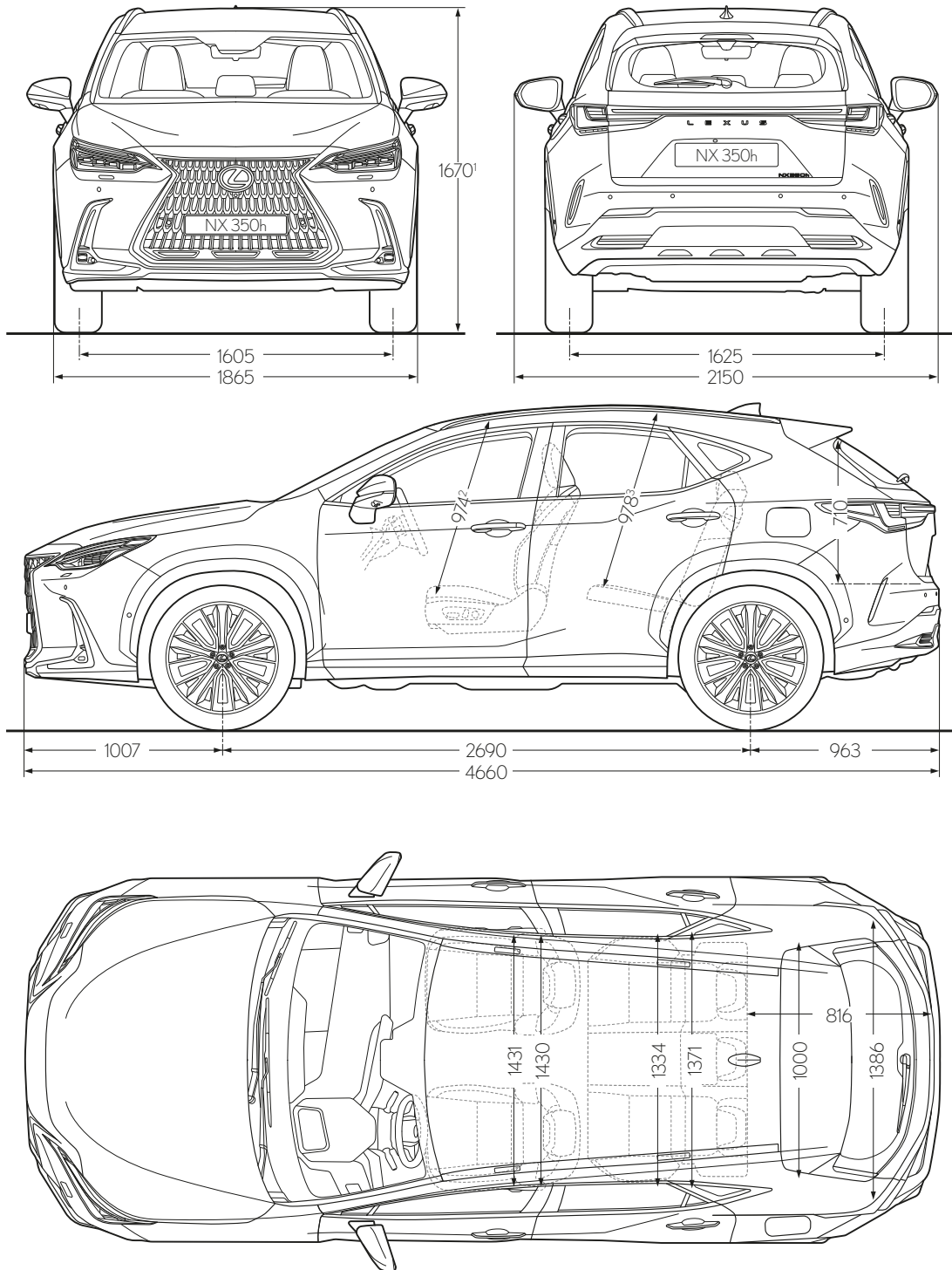

¹The figure quoted applies with 20" alloy wheels. When specified with 18" alloy wheels, the height is 1660.

²The figure quoted applies with standard roof. When equipped with glass sunroof, the headroom is 942. When equipped with panoramic glass sunroof, the headroom is 943.

³The figure quoted applies with standard roof. When equipped with glass sunroof, the headroom is 968. When equipped with panoramic glass sunroof, the headroom is 949.

Please note: the dimensions illustrated / noted are measured in millimetres.

BE OUR GUEST

HOW WE TREAT OUR CUSTOMERS IS GUIDED BY AN ANCIENT JAPANESE PHILOSOPHY OF HOSPITALITY.

Translated from the Japanese as 'hospitality and polite service', Omotenashi is about much more than excellence of service; it is an ancient concept centred around anticipating the needs of another, even before they arise. Omotenashi influences how we design and engineer our cars at Lexus, and equally how we treat you, the Lexus owner. Not just at the point of sale but over the life of your car. We want you to feel valued in every interaction you have with us. To feel more than a customer.

Whether as a private or fleet driver, you'll experience Omotenashi each time you visit our showrooms. In the warm reception on hand from friendly staff intent on welcoming you as if you were a guest in their home. In the inviting atmosphere and impressive facilities of the lounge, where you can avail of refreshments, catch up on news, enjoy high-speed Internet or carry on with your work. And in the knowledge that our Lexus technicians are working with precision and efficiency to get you back on the road with minimum interruption to your day.

PEACE OF MIND WITH LEXUS RELAX*. Lexus Relax provides you with complete peace of mind even after your manufacturer's warranty expires. Drive away carefree with an extra 12 months warranty every year you service your Lexus with us.

LEXUSEASY MOBILITY SOLUTION*. From financing to insurance, maintenance and even tyres, the Lexus Easy flexible mobility solution is the easy way to drive and look after a Lexus.

LEXUS INSURANCE*. Created especially for our new NX drivers, Lexus Insurance offers bespoke insurance products that provide high quality cover and cost efficiency. Take, for instance, our pioneering Lexus Full Hybrid Insurance* that rewards NX 350h drivers who make best use of their hybrid vehicle by driving safely in EV mode, with attractive savings on their insurance renewal premiums.

It's not only cars that make Lexus unique. It's the philosophy which permeates everything we do and which extends to an ownership experience that makes you feel special. Just as a guest should.

* Lexus Relax, Lexus Easy and Lexus Insurance are not available for all markets.
Please enquire at your local Lexus Authorised Retailer.





ÊTES-VOUS OUVERT
A
CUI VOUS SURPRENDRA

LES CONCESSIONNAIRES LEXUS

LEXUS



DISCOVER MORE ONLINE

Find out more about the new NX 350h and NX 450h+ and even reserve your car online. Take time to explore which equipment grade best suits your lifestyle, learn about our world-class service and finance offerings and sign up to our regular newsletter. If you're interested in how the new NX feels to drive, you can also book a test drive online with your local Lexus Retailer.

<http://www.lexus.eu/nx>



©2021 Lexus Europe* reserves the right to alter any details of specifications and equipment without notice. Details of specifications and equipment are also subject to change to suit local conditions and requirements. Please enquire at your local Lexus Authorised Retailer of any such changes that might be required for your area.

Note: vehicles pictured and specifications detailed in this brochure may vary from models and equipment available in your area. Vehicle body colour might differ slightly from the printed photos in this brochure.

For further information please visit our website: www.lexus.eu

Taking care of the environment is a priority for Lexus. We take many measures to ensure that during the lifecycles of our vehicles - from design, production, distribution, sales and service to end-of-life - their environmental impact is minimised. Your retailer will be happy to provide more information on end-of-life vehicle requirements.

* Lexus Europe is a division of Toyota Motor Europe NV/SA.

Printed in Europe, October 2021

 **LEXUS**
EXPERIENCE AMAZING